

Specification

Frequency: 26.7GHz
 Connector: FBP/FBE/FBM
 Loss: 1.25
 Return Loss: 0.4dB
 Connector: APC3.5 / SMA
 Material: #705
 Surface Treatment: SK

Cu gilding
 Cu passivation
 Al oxidation

Model selected

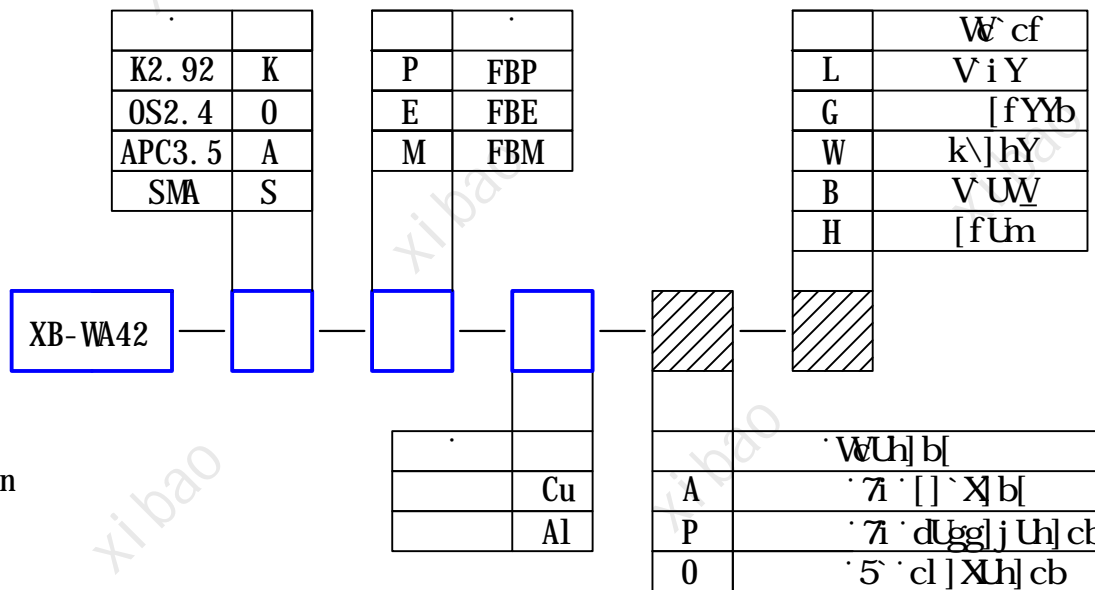

Instruction

Blue boxes are must required fields. Shadow boxes aren't option, randomly selected according to inventory.

Beijing Xibao Electronic Technology Co.,Ltd	
Waveguide to Coaxial Adapter(WR42/BJ220)	
www.beijingxibao.com 010-62312909 62327421	